

# Circuit-Breakers

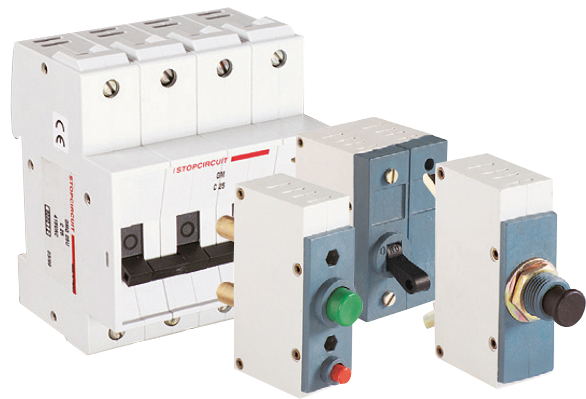

**STOPCIRCUIT**

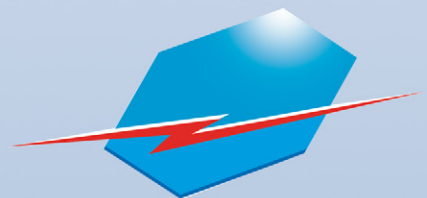

**STOPCIRCUIT**

# Galaxie

Circuit breakers

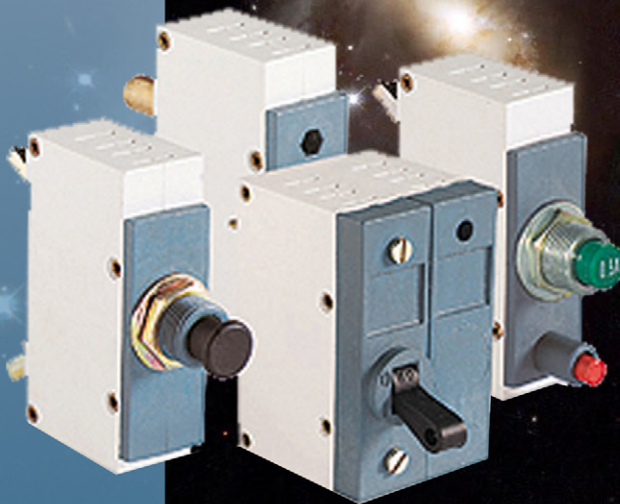

**Overload and Short-circuit Protection**

**Application fields:**

**Energy - Telecommunication - Industry**

**Rollingstock on rail and on road**

**Defence - Commercial Building - Boating**

## Summary

### Din Rail and Flush Mounting Miniature circuit-breakers

<b>General Characteristics</b>	<b>1</b>
Environmental characteristics	2
Electrical characteristics	2

### GD - GN - GV - GA series

Dimensions - Fastenings - Terminals	3
Fastening / Operations and Terminals table Accessories	4
Options	5
Product coding	6

### GM - GF - GC Series

Dimensions	7
Options	7
Product coding	8

### Tripping curves

GD - GA - GM series	9
GN - GV - GF - GC series	10

### Subminiature circuit breaker - TINY series

General characteristics	11
Electrical and mechanical characteristics	11
Part number	11
Dimensions and cutout	12
Tripping curves	12

# Miniature Circuit-Breakers STOPCIRCUIT

60 years of expertise in the protection field of the Human and Tool machines



Adaptability  
Flexibility  
Safety  
Reliability



The STOPCIRCUIT circuit-breakers meet all requirements of the Standards

- In compliance with IEC 60 898 Standard.
- In compliance with NF F62 001 Standard regarding the rollingstock railway.
- In compliance with NF F16 101 and 16 102 Standards concerning the smoke and fire.
- Withstand to vibrations and shocks
- Thermal compensation from -40°C to +85°C (on GD Series only)

## Advantages of the products

- Operating voltage up to 150Vdc per pole for DC versions
- Thermal magnetic detection; magnetic only; thermal only
- Strong shock withstand allowing use in harsh environments, especially in military applications
- Special product according the customer requirements
- Rated currents on request
- Fastening and operation on request
- Marking of Rated current on the latching button
- Waterproof accessorie on front part

## Application fields

- Railway - Defence - Road transport - Boating - Telecommunication
- Energy (EDF) - Industry - ...

The circuit breakers STOPCIRCUIT provides for a multitude of combinations and adaptations. The examples illustrated in this catalogue only represent a fraction of designs produced by our design office every day for our customers

All alternative solutions can be designed from the basic elements, to produce the desired function.



Our products meet the RoHs European Directive, limiting the use of certain hazardous substances in electrical equipments

## Environmental characteristics

<b>According to the Standards</b>	NF F62 001 / IEC 60 898 / IEC 60 947-2
<b>Fire / Smoke</b>	I2F3 according to NF F16 101 and 16 102
<b>Withstand to the sinusoidale vibrations</b>	4g / 11ms
<b>Withstand to the mechanical shocks</b>	Standard: 30G / 11ms _ Up to 100G as an option
<b>Operating temperature</b>	Standard: -5°C to +40°C _ Up to -40°C to +85°C as an option

## Electrical and mechanical characteristics

<b>Alternative nominal voltage (F = 50 / 60Hz)</b>	GD & GM Series: 240Vac (1 protected pole + neutral) 240 / 415Vac (1 pole version) 415Vac (multipole versions)																
<b>Direct nominal voltage per pole</b>	GN & GF Series: 100Vdc max (1 pole and 2 pole versions) GV & GC Series: 150Vdc max (1 pole and 2 pole versions) GD & GM Series: 48Vdc max (1pole and 2 pole versions)																
<b>Dielectric withstanding voltage:</b>	2 000V rms																
<b>Magnetic threshold tripping:</b>	B characteristic: 3 In to 5 In C characteristic: 5 In to 10 In D characteristic: 10 In to 20 In S characteristic: 5 In to 10 In (rated current ≤ 2A) S characteristic: 7 In to 14 In (rated current ≥ 3A)																
<b>Breaking capacity:</b>	<table border="0"> <tr> <td>Thermal magnetic:</td> <td>GD Series: 3 kA according to IEC 60 898</td> </tr> <tr> <td></td> <td>GN Series: 500A according to NF F62 001</td> </tr> <tr> <td></td> <td>GV Series: 1 000A according to NF F62 001</td> </tr> <tr> <td></td> <td>GM Series: 6 kA according to IEC 60 898</td> </tr> <tr> <td></td> <td>GM Series: 10kA according to IEC 60 947-2</td> </tr> <tr> <td></td> <td>GF Series: 1 000A according to NF F62 001</td> </tr> <tr> <td></td> <td>GC Series: 1 500A according to NF F62 001</td> </tr> <tr> <td>Thermal only:</td> <td>All Series 10 In rating &lt; 5A / 20 In rating ≥ 5A</td> </tr> </table>	Thermal magnetic:	GD Series: 3 kA according to IEC 60 898		GN Series: 500A according to NF F62 001		GV Series: 1 000A according to NF F62 001		GM Series: 6 kA according to IEC 60 898		GM Series: 10kA according to IEC 60 947-2		GF Series: 1 000A according to NF F62 001		GC Series: 1 500A according to NF F62 001	Thermal only:	All Series 10 In rating < 5A / 20 In rating ≥ 5A
Thermal magnetic:	GD Series: 3 kA according to IEC 60 898																
	GN Series: 500A according to NF F62 001																
	GV Series: 1 000A according to NF F62 001																
	GM Series: 6 kA according to IEC 60 898																
	GM Series: 10kA according to IEC 60 947-2																
	GF Series: 1 000A according to NF F62 001																
	GC Series: 1 500A according to NF F62 001																
Thermal only:	All Series 10 In rating < 5A / 20 In rating ≥ 5A																
<b>Rated currents (Standard rated currents in bold)</b> (A)	0.1 - 0.2 - 0.3 - 0.5 - 1 - 1.5 - 2 - 2.5 - 3 - 4 - 5 - <b>6</b> - 8 - 10 - 12 - 13 - 16 - <b>20</b> - 25 - 30 - <b>32</b>																
<b>Service life: number of cycles (on / off):</b>	4000 cycles																

# Miniature Circuit-Breakers : GD - GN - GV - GA Series



## Flush mount or unpluggable versions. Dimension drawings, fastenings and terminals

**Flush mount versions. Circuit breaker one pole to 3 poles. Mounting by screws or by plastic threaded bush (or metal, option W)**  
Fastening and operations N° 03 - 04 - 06 - 07 - 08 - 09 (see table page 4)

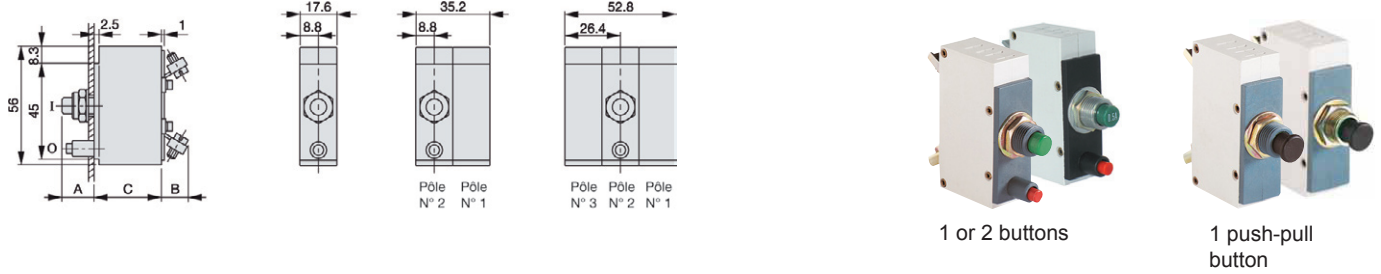

**Flush mount versions. Circuit breaker one pole to 4 poles. Mounting by screws**  
Fastening and operations N° 05 (see table page 4)

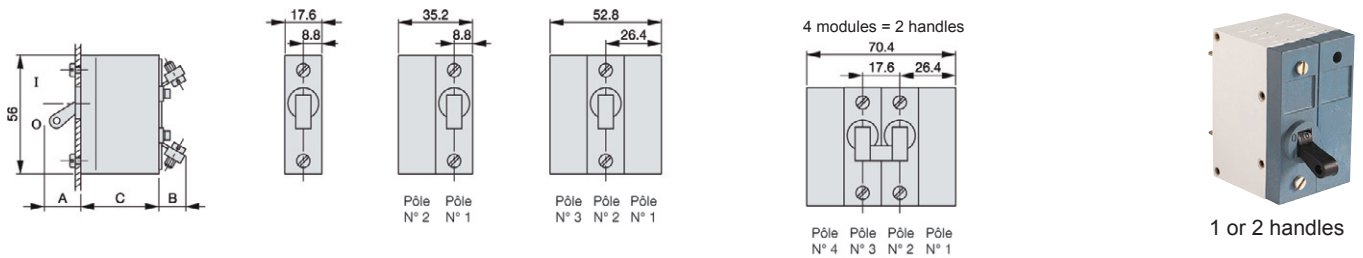

**Unpluggable versions. Circuit breaker one pole to 4 poles. Bases on DIN Rail or plate**  
Fastening and operations N° 00 - 01 - 02 and terminals 00 or 10 (see table page 4)

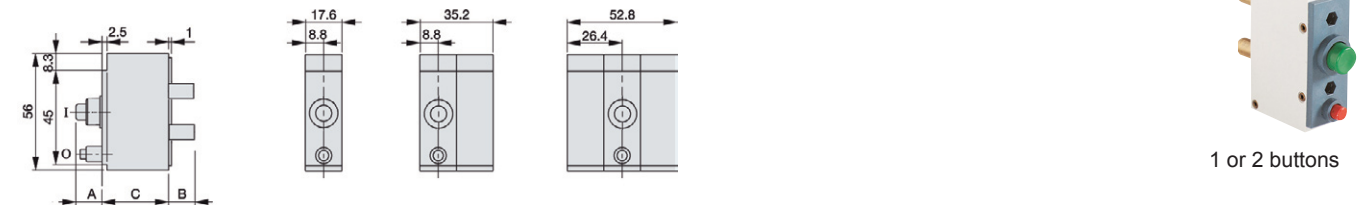

### Fastening drawings

Projection

Screw fastening

Fastening threaded bush

Tightening torque:  
1.8Nm max with plastic bush  
3Nm max with metal bush

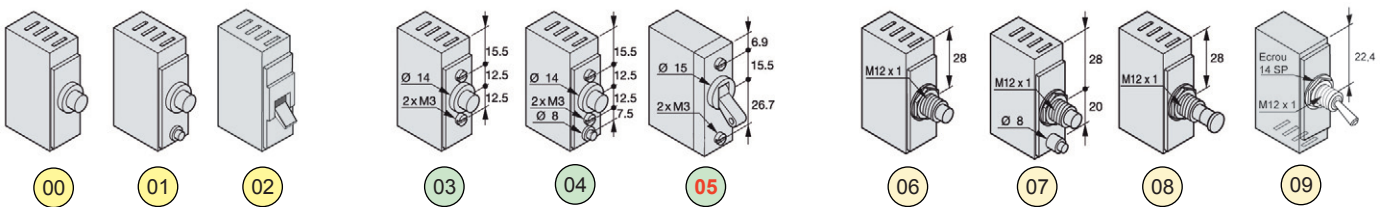

### Terminals

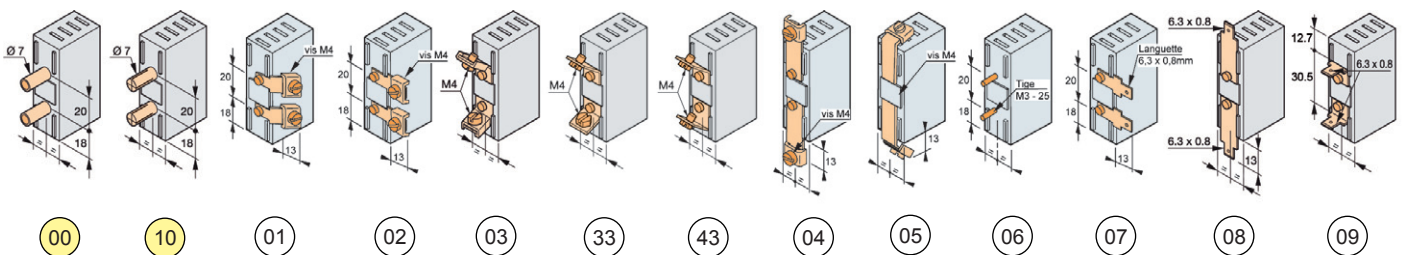

## Fastening / Operations and Terminals table

	Unpluggable			Screw			Threaded bush						
Fastening / Operations	00	01	02	03	04	05	06	07	08	09			
Dimension : A (mm)	8	8	8	8	8	17.5	15	15	21	28			
Dimension : C (mm)	32	32	32	32	32	37	32	32	32	32			
Panel thickness maximum				3	3	3	6	6	6	6			
Terminations	00	01	10	02	03	33	04	43	05	06	07	08	09
Dimension : B (mm)	15	4	15	4	12	12	4	12	4	7	4	4	11

## Accessories

### Bases for unpluggable circuit breakers - On plate

Number of auxiliary change-over contacts	1 pole	2 poles	3 poles	4 poles
0	821B10001	821B20001	821B30001	821B40001
1	821B10101	821B20101	821B30101	821B40101
2		821B20201	821B30201	821B40201
3			821B30301	821B40301
4				821B40401

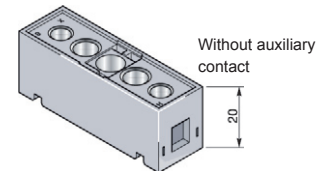
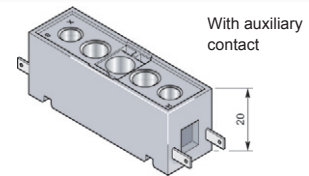
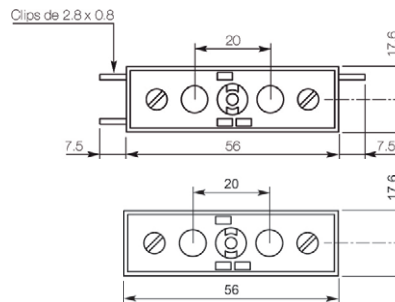

### Bases for unpluggable circuit breakers - On P.C.B. - With terminals N° 09

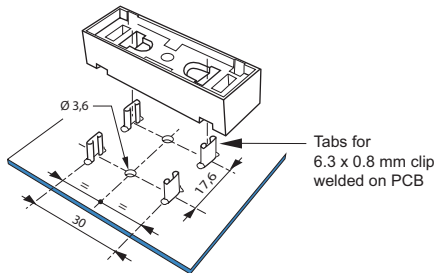

Part number  
**B110**

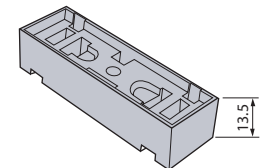
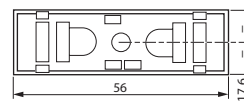

### Bases for unpluggable circuit breakers - On DIN Rail 1 - 3

Number of auxiliary change-over contacts	1 pole	2 poles	3 poles	4 poles
0	821B13001	821B23001	821B33001	821B43001
1	821B13101	821B23101	821B33101	821B43101
2		821B23201	821B33201	821B43201
3			821B33301	821B43301
4				821B43401

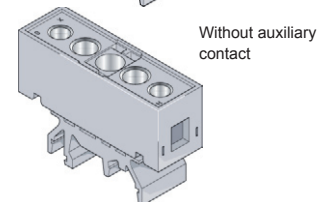
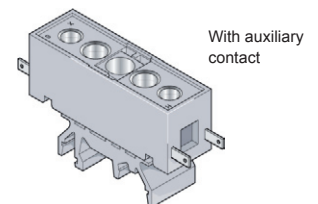
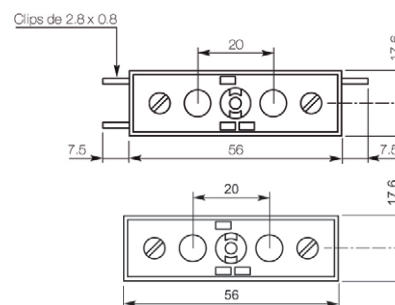

## Sealing

Description Part number

Hooded sealing for fastening / operation N° 06

821E20601



Hooded sealing for fastening / operation N° 08

821E20801



Equipment sealing for fastening / operation N° 09 .

821E10001

1 ring, 2 seals (providing a seal to the artificial rain in front face)  
Requires the T option for the circuit-breaker

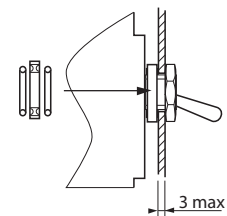

## Options

### Change-over auxiliary contacts

Maximum value:  
3A under 240 VAC / 48 VDC  
Minimum value:  
5 mA under 15 VDC

Connection with tabs 2.8 x 0.8  
for clips (terminals S.H.X.)

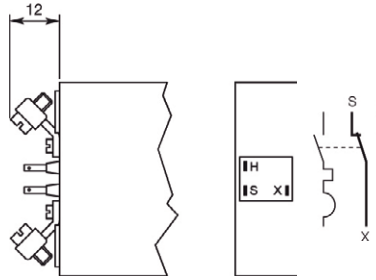

### GD series Circuit-breaker, model D with thermal protection adjustable

The magnetic thresholds are defined according to the D curve and from the lowest rated current of the range

Adjusting range:  
0.1 / 0.16 - 0.16 / 0.25 - 0.25 / 0.4  
0.4 / 0.6 - 1 / 1.6 - 1.6 / 2.5 -  
2.5 / 4 - 4 / 6 - 6 / 10 A

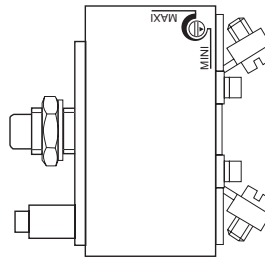



## How to order GD - GN - GV - GA series circuit-breaker

### Example:

1 Circuit-breaker - **Serie** : Galaxie standard AC - **Version** : 2 protected poles - **Rating** : 10 A - **Model** : magnetic-thermal, curve C  
 - **Fastenings and operations** : Threaded bush flush type 2 buttons - **Terminations** : Screws and back connectors  
 - **With Options** Auxiliary for position signalling O/F : on 1 pole - Tropicalization

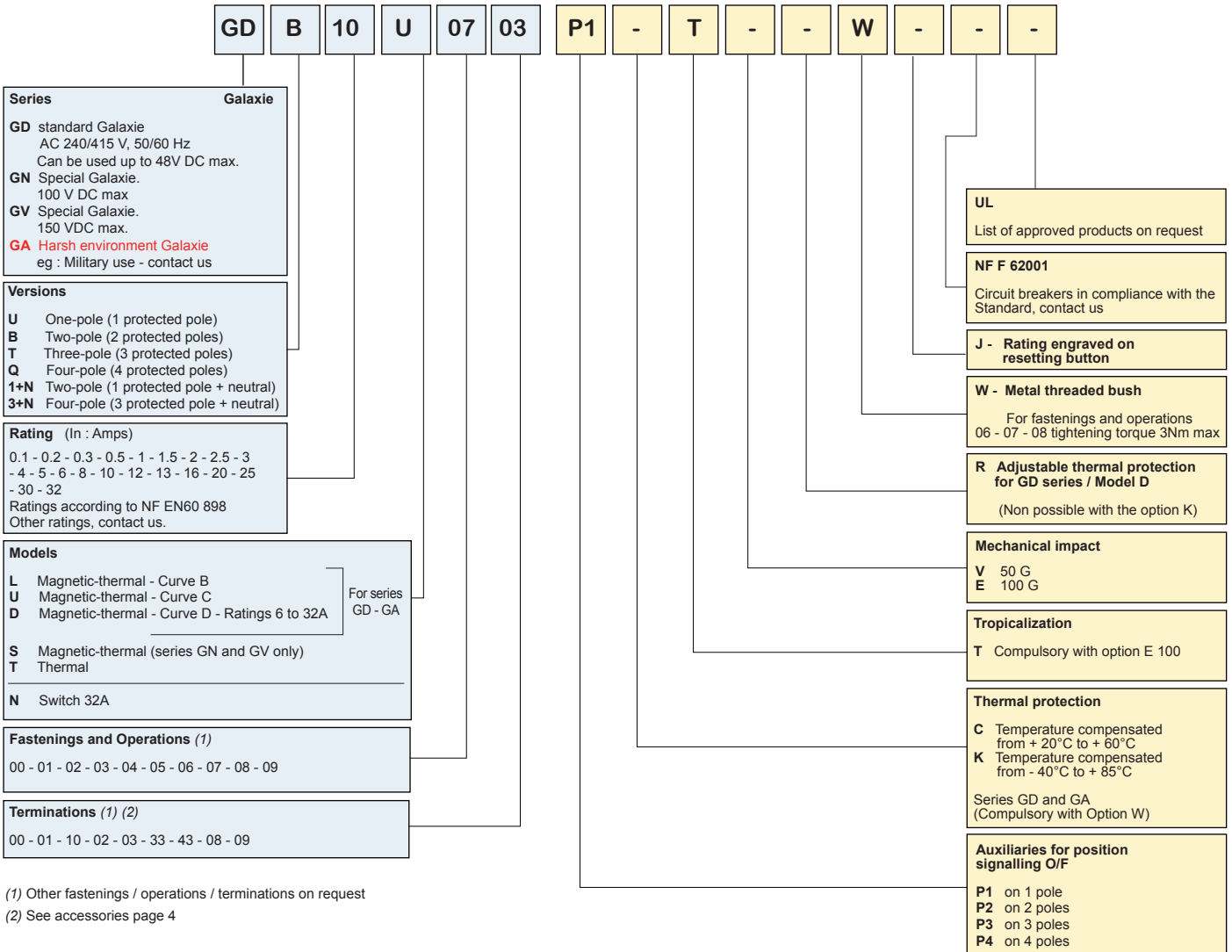

### Special design circuit-breakers

We design special circuit-breakers, by-products of the GALAXIE range, on customer's specification (Type GS...). These devices are described on specific technical data sheets.

**Contact us**

## DIN Rail mount versions

### Dimensions drawings

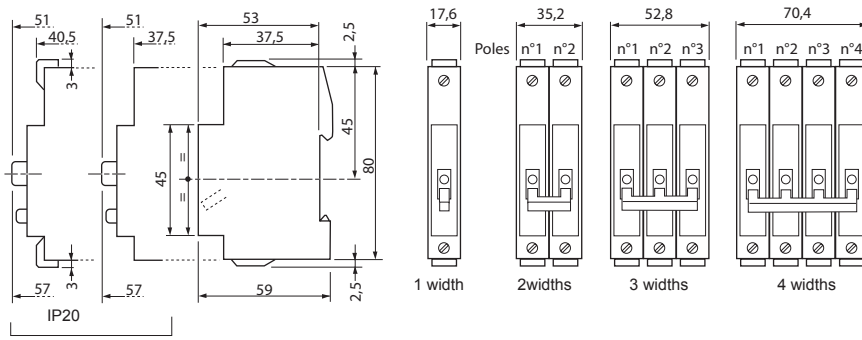

Operation 01  
(2 buttons)



Notes: Operation N° 00 or 01 on the first pole if 2 poles, or on the second pole if 3 poles

## Options

### Auxiliary for position signalling (O/F)

Switching capacity (resistive circuit)

Maximum value:  
3A under 240 VAC / 48 VDC

Minimum value:  
5 mA under 15 VDC

Connection with tabs 2.8 x 0.8 for clips (terminals S.H.X.)

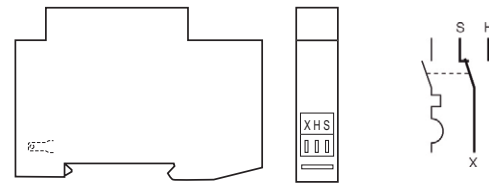

Adapter for mounting on DIN 1 / DIN 3 rail

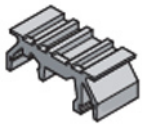

Part number :  
821A46601

GM, GF, GC can be ordered equipped with a push button  
up to 3 poles versions

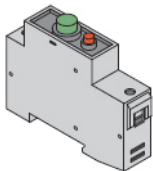

## How to order GM - GF - GC series circuit-breaker

### Example:

1 Circuit-breaker - **Serie** : Galaxie Modular AC - **Version** : 4 protected poles - **Rating** : 16 A - **Model** : magnetic-thermal, curve C  
 - **Options** : Any

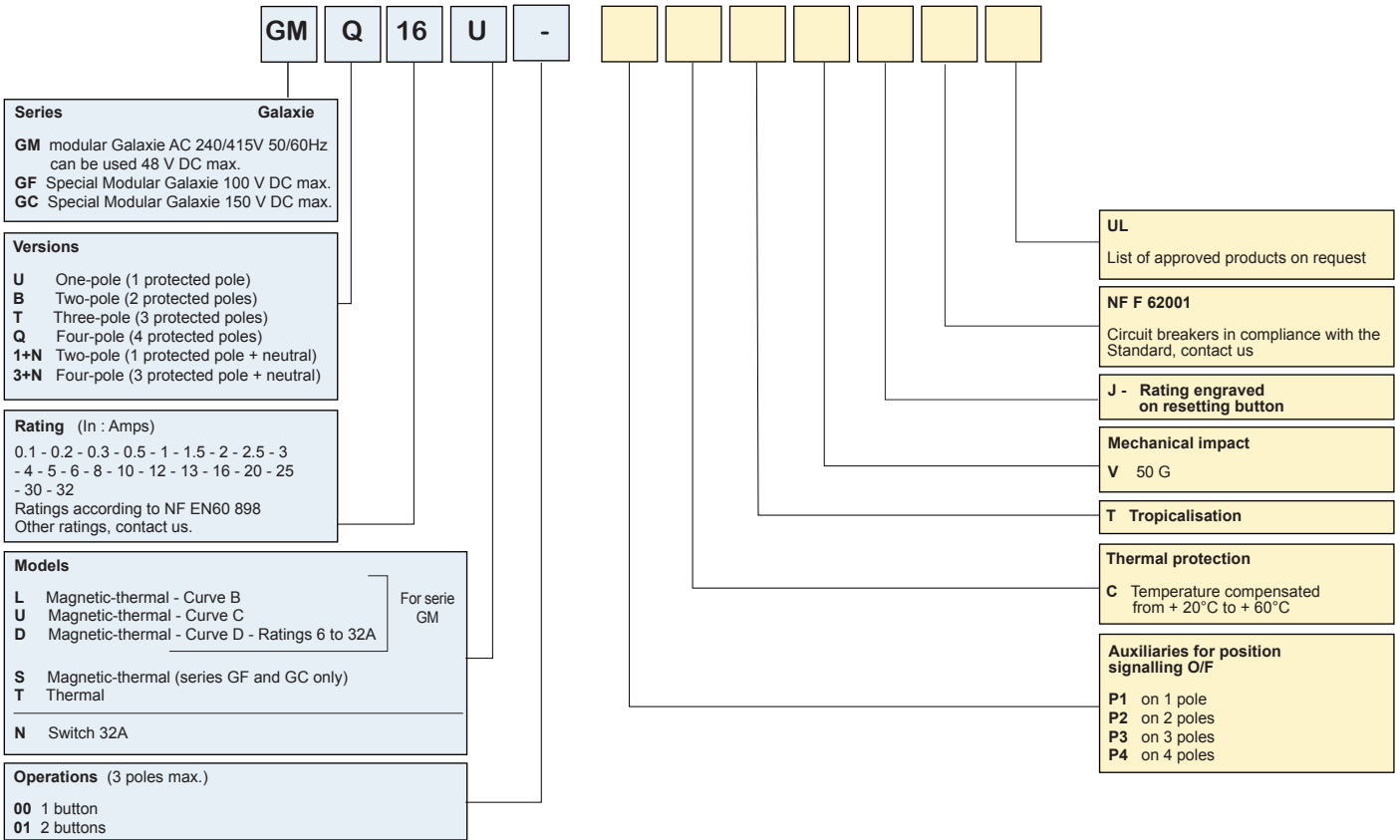

### Special design circuit-breakers

We design special circuit-breakers, by-products of the GALAXIE range, on customer's specification (Type GS...). These devices are described on specific technical data sheets.

**Contact us**

## Tripping curves for GD, GA and GM series

Test realized :

- cold ( $I = 0$  before overload)
- overload on all the poles for multipoles

- ▽ ▽ Limits standard
- For information

Alternative current (at +30°C according to IEC 898 standard)

**CURVE B**

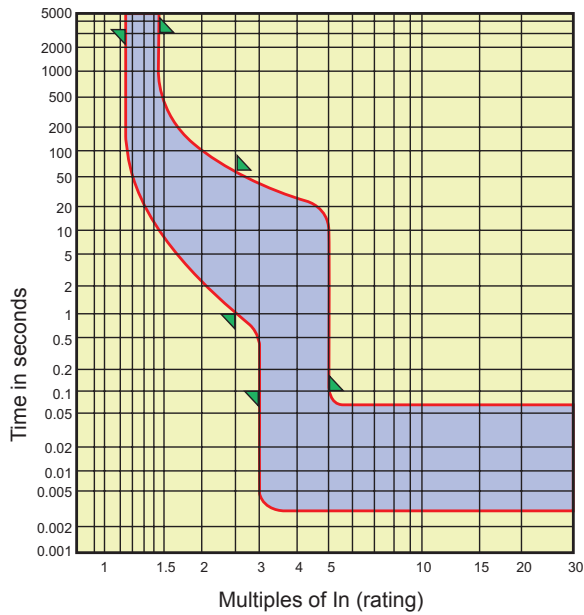

**CURVE C**

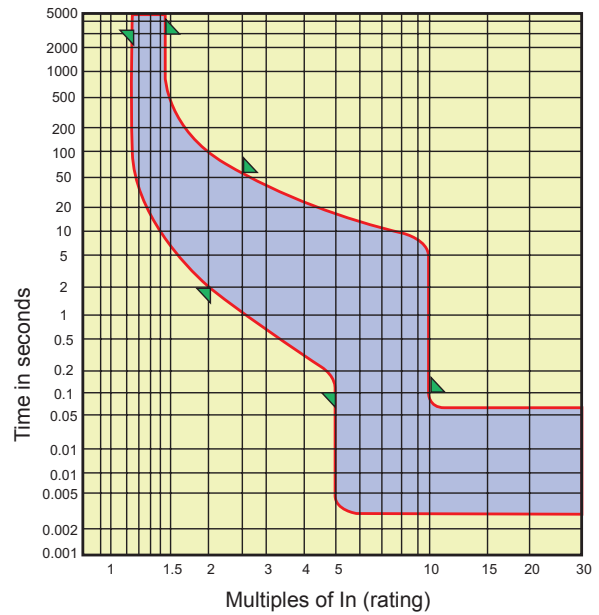

**CURVE D**

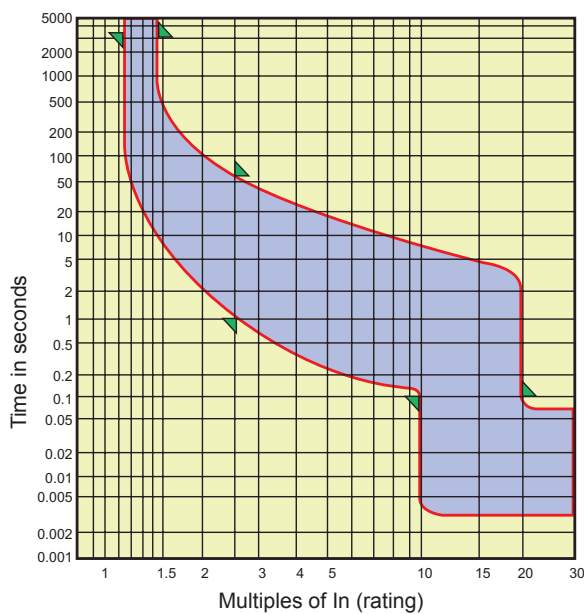

## Tripping curve for GN, GV, GF and GC series

Test realized :

- cold ( $I = 0$  before overload)
- overload on all the poles for multipoles

- ▴ ▾ Limits standard
- For information

Thermal magnetic DC current curves for GF, GC, GN and GV series - S model

(direct current, at +20°C according to NF F 62001 standard)

CURVE S for rating from 0,1A to 2A included

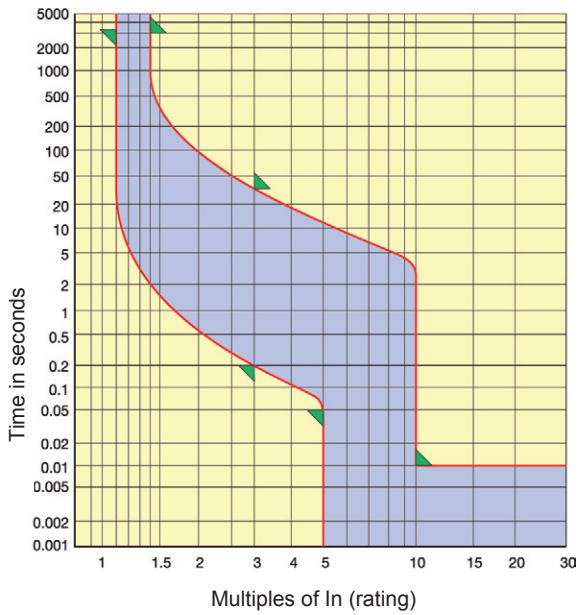

CURVE S for rating from 3A to 32A included

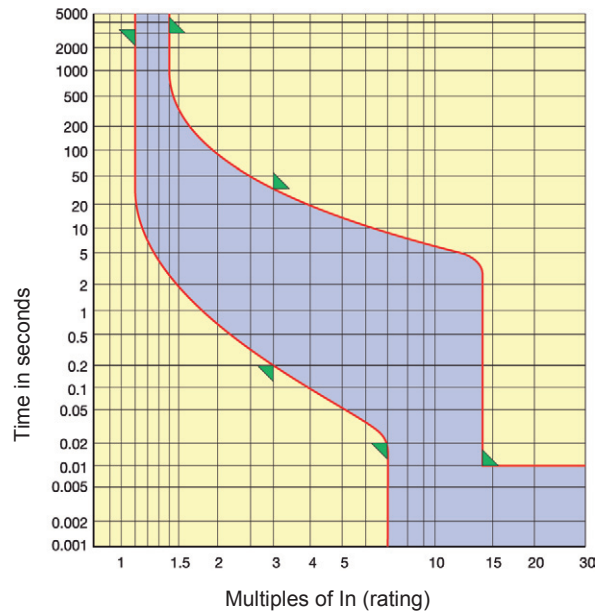

Curves of thermal alternative or direct current for GM, GD, GF, GC, GN and GV series - T model

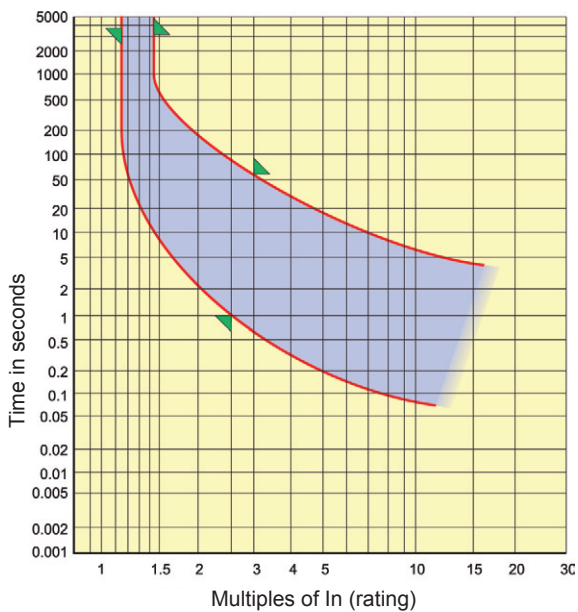

# Special Circuit-Breakers : TINY series



## Subminiature Circuit-Breaker for printed circuit board - TINY series

- Equipped with a "thermal" type detection device - It can withstand transitory currents avoid untimely tripping which the capacitors fitted in the protected circuit may cause - No polarity - Fitted with a sliding resetting switch (position of contact visible by its position) .

The TINY circuit breaker allows :

- resetting after automatic tripping
- manual tripping (switch function)

## Electrical and mechanical characteristics

<b>Breakdown voltage :</b>	> 1 500 V
<b>Power consumption under rating current:</b>	< 0.20 Watt
<b>Lifetime of contacts:</b>	500 cycles under 24V DC, 5 Amps
<b>Surge voltage withstanding:</b>	3 kv surge (1.2/50µs)
<b>Contacts:</b>	Silver alloy
<b>Ambient temperature:</b>	-20° C to 60° C
<b>Rated currents (A)</b> Rating marked on the casing	0.1 - 0.2 - 0.4 - 0.6 - 1 - 1.6 - 3
<b>Service life: number of cycles (on / off):</b>	500 cycles under 24 V DC and rating current
<b>Operanting voltage :</b>	24 V DC or 24 V AC - Other voltage, contact us.

## TINY series

As it is compact with a related high rupturing capacity, this circuit breaker is highly suitable to protect printed circuit boards against high currents and short circuits.

Rating in Amps	Standard terminals (straight)	Part number	Weight (g)
0.10	TY 0.10	809012001	1.2
0.20	TY 0.20	809014001	
0.40	TY 0.40	809017001	
0.60	TY 0.60	809019001	
1.00	TY 1	809023001	
1.60	TY 1.60	809026001	
3.00	TY 3	809032001	



Curved terminals on request.

For other P.C.B. applications, it is possible to use our screw flush mounting GD - GN - GV series.

## Dimensions and cutout

Spacing 5 mm (.196")

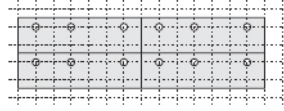
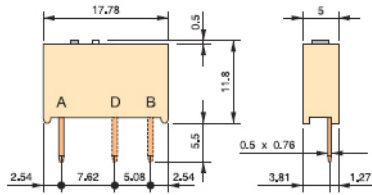

Layout on spacing 2.54 mm grid.

Thickness P.C.B. :  
0.6 to 3.2 mm

P.C.B. holes  $\varnothing$  1 mm

Rating 1.6 A :  
Leads A and B

Rating  $\geq$  1.6 A :  
Leads A and D

## Tripping curve for TINY series

### Rupturing capacity:







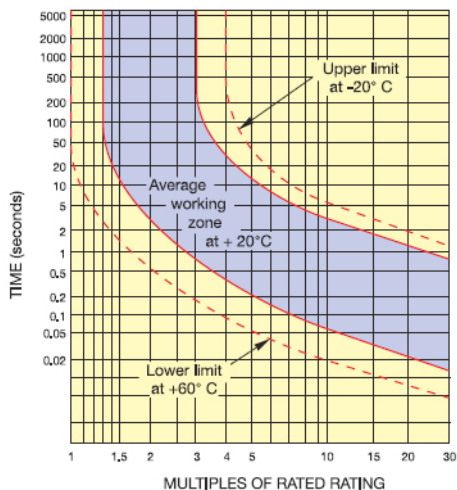





At 24 V DC, resistive load

Rating	Presumed current	True current	Breaking time at 20° C
0.10 A		2 A	150 - 500 ms
0.20 A	10 A	4 A	150 - 500 ms
0.40 A	14 A	10 A	150 - 400 ms
0.60 A	15 A	12 A	100 - 400 ms
1.00 A	14 A	13 A	200 - 700 ms
1.60 A	33 A	32 A	50 - 150 ms
3.00 A	46 A	45 A	80 - 300 ms

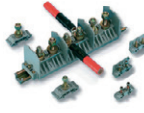
Tripping curves with no warming up time



## Consult our other catalogues

<p>Catalogue <b>GB-E6-1</b></p> <p><b>Control components</b></p> 	<p>Catalogue <b>GB-B2-1</b></p> <p><b>Standard 16 A switches and Low level switches with self-cleaning contact</b></p> 	<p>Catalogue <b>GB-B3-2</b></p> <p><b>16A to 400A AC/DC Snap action switches</b></p> 
<p>Catalogue <b>GB-E1-4</b></p> <p><b>Standard and special Indicator lights</b></p> 	<p>Catalogue <b>GB-E7</b></p> <p><b>LED Marker / Tail lights</b></p> 	<p>Catalogue <b>GB-E8</b></p> <p><b>Display &amp; Signalling</b></p> 
<p>Catalogue <b>GB-G1-2</b></p> <p><b>Low and medium voltage Insulators and Partitions bushings</b></p> 	<p>Catalogue <b>GB-F4-1</b> <b>Contact us</b></p> <p><b>BR500 junction terminals</b></p> 	<p>Catalogue <b>GB-F2-2</b></p> <p><b>Stud junction terminals</b></p> 
<p>Catalogue <b>GB-L1</b></p> <p><b>Watertight control boxes</b></p> 	<p>Catalogue <b>GB-D2-2</b></p> <p><b>Pendant control boxes</b></p> 	<p>Catalogue <b>GB-L2-2</b></p> <p><b>ORCA Range</b></p> 
<p>Catalogue <b>GB-A7-1</b></p> <p><b>M-DOOR range</b></p> 	<p>Catalogue <b>GB-DJ-A1</b></p> <p><b>Circuit-Breakers</b></p> 	<p>Catalogue <b>GB-MC-A1</b></p> <p><b>Snap-action Microswitches &amp; Limit switches</b></p> 



471 Route de la Cuisinière  
38 490 CHIMILIN-FRANCE  
Ph. : +33 (0)4 76 32 07 33  
Fax : +33 (0)4 76 32 54 11

121, Bd de la Résistance  
71000 MÂCON - FRANCE  
Ph. : +33 (0)3 85 20 94 20  
Fax : +33 (0)3 85 34 64 90

[contact@mafelec.fr](mailto:contact@mafelec.fr) - [www.mafelec.com](http://www.mafelec.com)